

SBS63XDE



Product familie	Koelkast
Installatie	Vrijstaand
Categorie	Side-by-side koel-vriescombinatie
Referentie breedte	Meer dan 80 cm
Referentie hoogte	160 - 200 cm
No Frost systeem	Totaal No-Frost
Type koelen	Geventileerde koelkast, No Frost vriezer
Ontdooien	Automatisch ontdooien
Type scharnier	Standaard
EAN-code	8017709337636



Design



Design	Universeel	Materiaal zijwanden	Staal
Kleur	Inox-look	Kleur zijkanten	Zilver
Design	Plat	Logo	Geassembleerd
Materiaal deur	Inox look	Kleur profielen laden	Zilver
Handgreep	Extern	Kleur profiel glazen leggers	Zilver
Type handgreep	Vast	Display	LED
Kleur handgreep	Inox	Positie display	Esterno (su porta)
Kleur logo	Chroom		

Uitrusting koelkast



Aantal verstelbare leggers	3	Type afdekplaat groente-/fruitlade	Glas
Aantal groente-/fruitlades	2	Life Plus zone 0°C	Ja
Type verstelbare leggers	Glas	Binnenverlichting koelkast	Ja
Type afdekplaat groente-/fruitlade	Standaard	Type binnenverlichting koelkast	LED
Afdekplaat groentenlade	Ja		

Binnendeur koelkast

Aantal verstelbare
binnendeurcompartimenten 4

Aantal flessenhouders 1

Overige features koelkast



Accessoires Eierhouder
Natural Plus Blue Light Ja
MultiFlow Ja

Ventilator Ja
Active Ion technology Ja
Anti bacteriële
geurfilter Ja

Uitrusting vriezer

Aantal lades 2
Aantal legplanken 4
Binnenverlichting
vriezer Ja

Type verlichting vriezer LED
Type leggers Glas

Binnendeur vriezer

Aantal
binnendeurcompartimenten 4

Overige features vriezer



Ijsmaker (manueel) Ja
Ice maker Manueel ontdooien

Snel-vriescompartiment Ja

Overige technische eigenschappen



Display functies
Snel-vriestoets
Alarm open deur
Temperature Alarm
Type temperatuurcontrole
Aantal compressoren
Type koelgas
Schuimmiddel

Vakantiefunctie, Snel-vriesfunctie, Snel-koelfunctie, ECO,
Kinderbeveiliging, Temperatuuralarm
Ja
Ja
Ja
Elektronisch
1
R600a
Cyclopentaan

Prestaties/Energie label - Reg. 2019









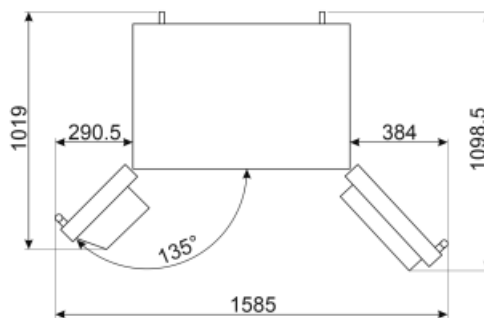
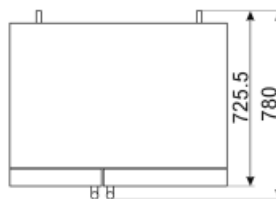
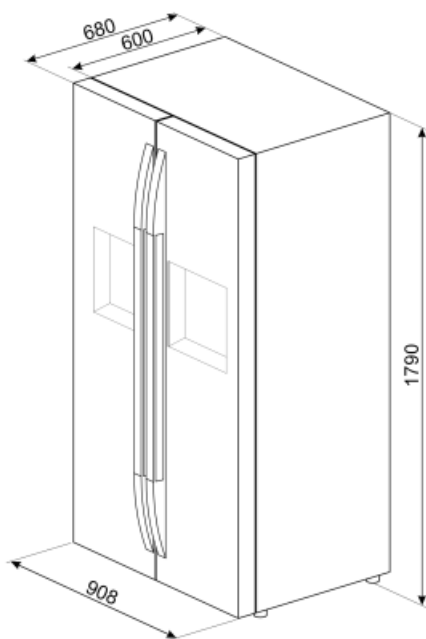







Annual energy consumption	327 KWh/jaar	Geluidsniveau	38 dB(A) re 1pW
Energie-efficiëntieklasse	E	Conserveringsduur zonder stroom	9 h
Emissieklasse voor akoestisch luchtgeluid	C	4 star - Freezing capacity	13.0 Kg/24h
Totaal netto volume	580 l	Klimaatklasse	SN, N, ST, T
Netto inhoud vriesgedeelte	212 l	EEl	99 %
Netto inhoud koelgedeeltes	368 l		

Elektrische aansluiting

Stekker	(F;E) Schuko	Spanning (V)	220-240 V
Nominale aansluitwaarde	150 W	Frequentie (Hz)	50 Hz
Stroom (A)	0,85 A	Lengte stroomkabel	215 cm



Symbols glossary (TT)

	Smeg Active Ion system improves the quality of the air inside the cell. Thanks to the generation of negatively charged ions released inside the fridge Active Ion system neutralizes unpleasant dust.		The automatic defrost system works by automatically defrosting at regular intervals eliminating the need to defrost altogether.
	Sommige modellen zijn voorzien van een functie om het programma/de cyclus te blokkeren zodat het niet per ongeluk kan aangepast worden.		LED display: to show programmes, functions and options selected and the time to the end of the cycle.
	Economical mode: Analyzes fridge functioning during the activation and optimizes the operating cycle in order to reduce power consumption.		Geventileerd: een geforceerde verdeling van koude lucht in het koelkast compartiment, die een gelijke temperatuurverdeling verzekert in de koelkast.
	Fast freezing: The fast freezing function brings the temperature of the compartment down when activated a few hours prior to usage.		Power saving mode: The power saving mode allows you to disable the refrigerator and keep the freezer working.
	LED interior lighting: is a more energy efficient and long lasting way of illuminating the interior of the appliance.		Life Plus 0°C: The temperature in the Lifeplus compartments is kept at 0°C, which preserves fresh meat and fish longer.
	Air plus: keeps food fresher for longer.		Natural Plus Blue Light: Dit unieke Natural Plus Blue Light-systeem verlengt de bewaartijd van groenten en fruit
	No Frost: The No Frost and Frost free systems prevent ice from forming so that no defrosting is required.		Energie-efficiëntieklasse